

Scripts を使用して部品ライブラリー作成

AL_SMD_DW

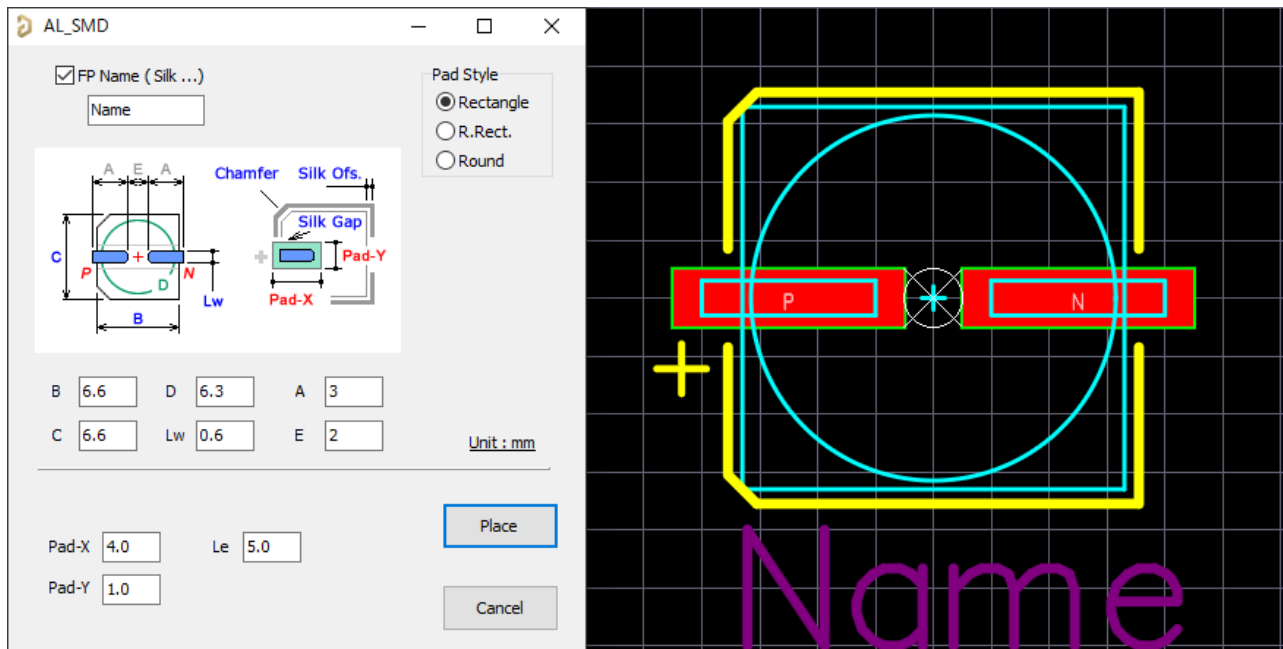

AVR_TO_DW

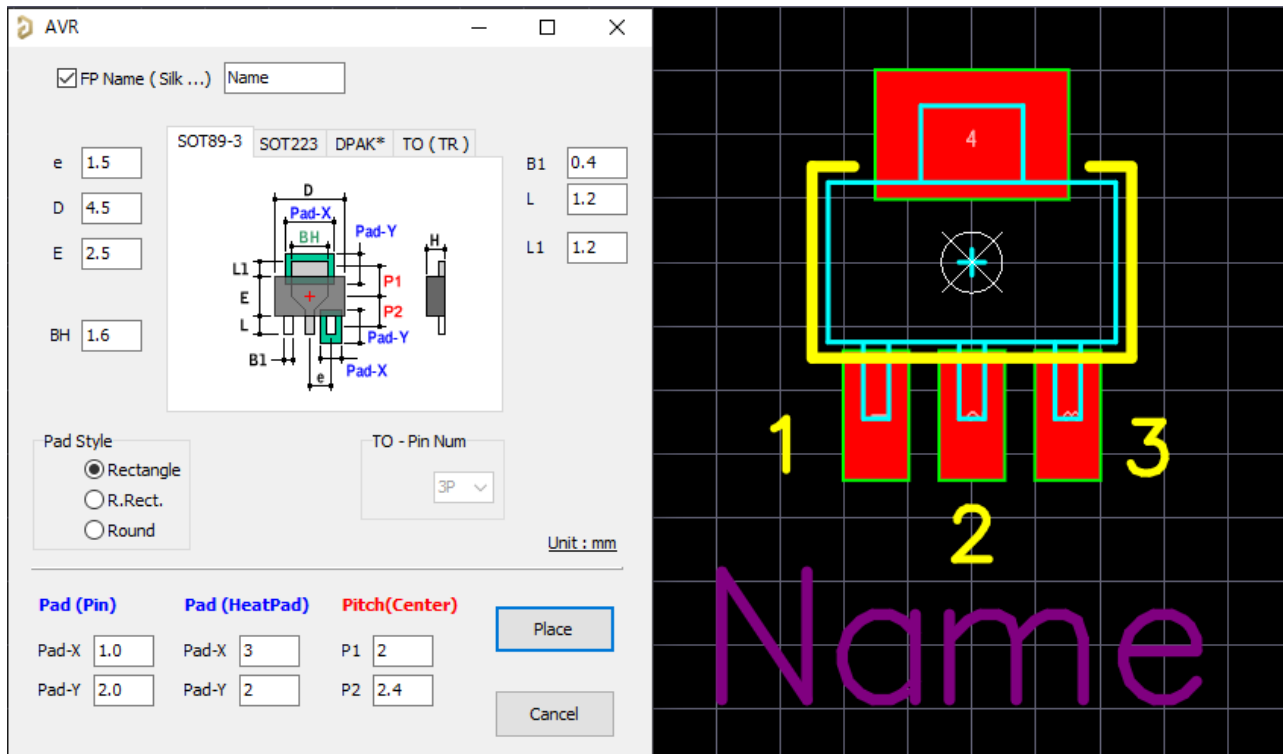

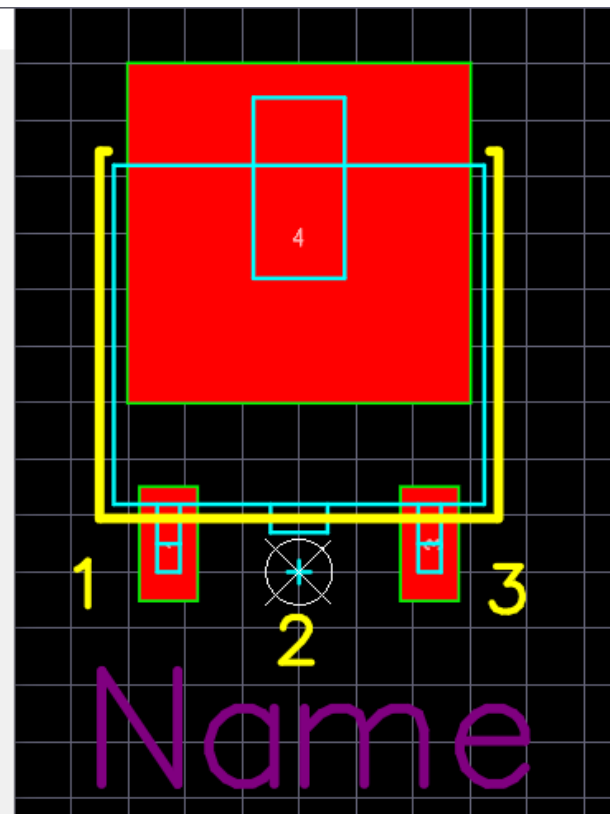
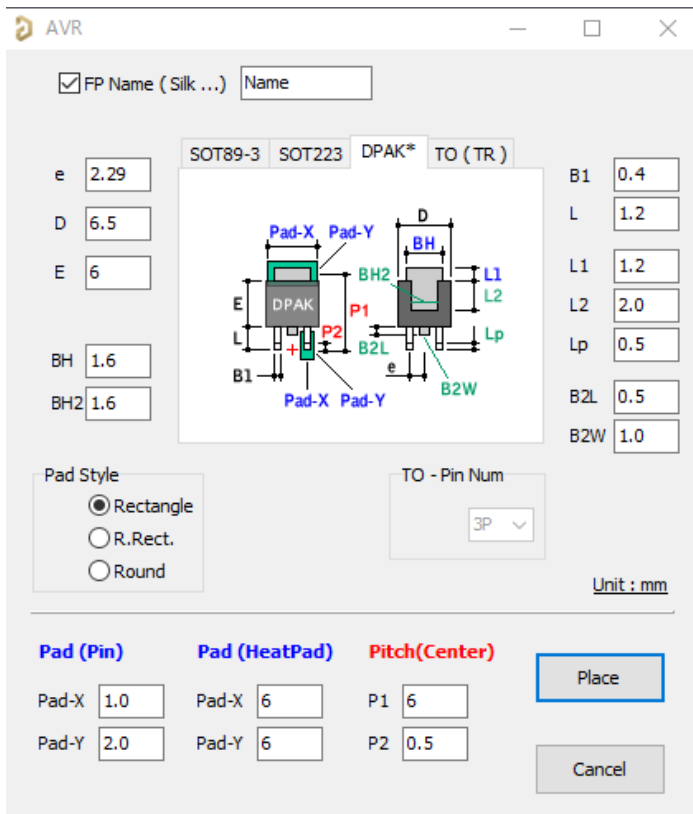
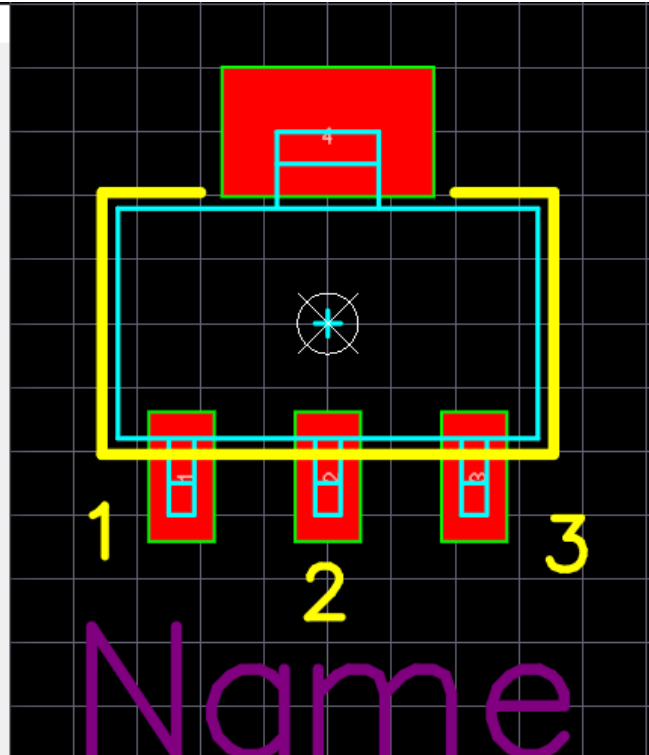
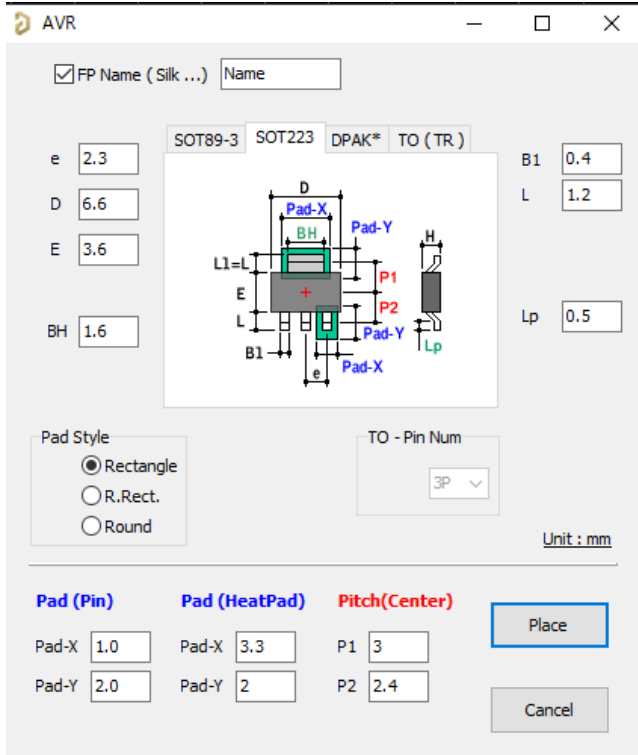

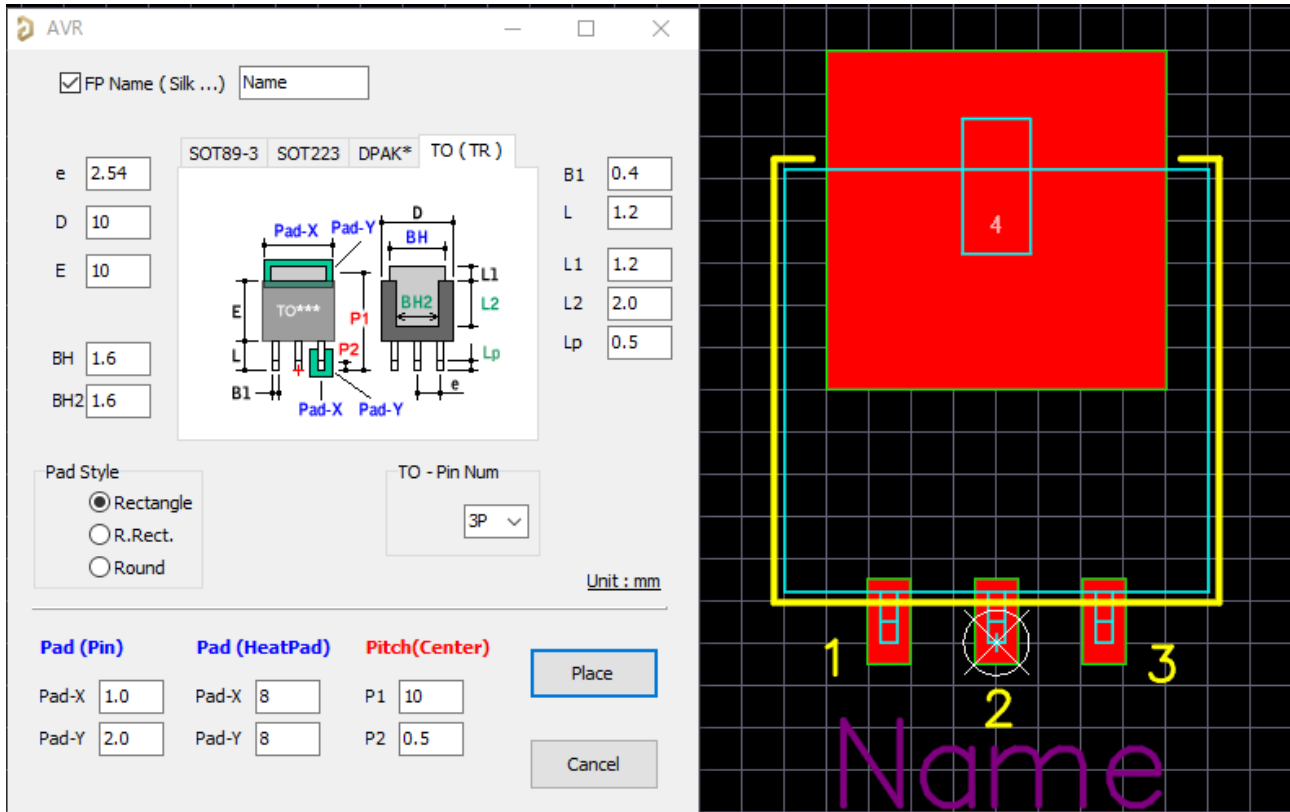

CN_DW

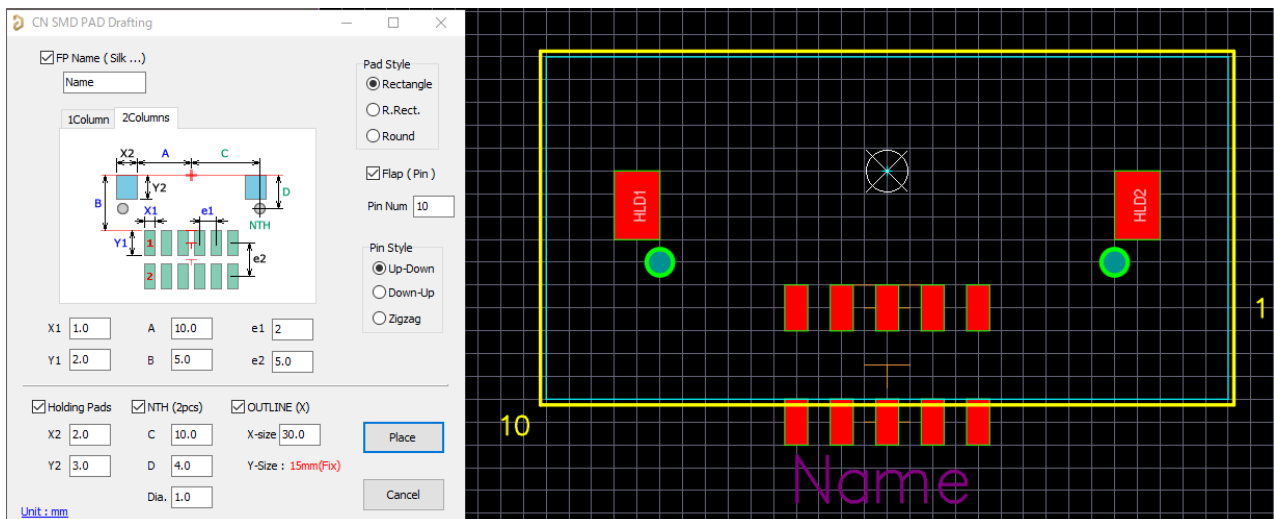
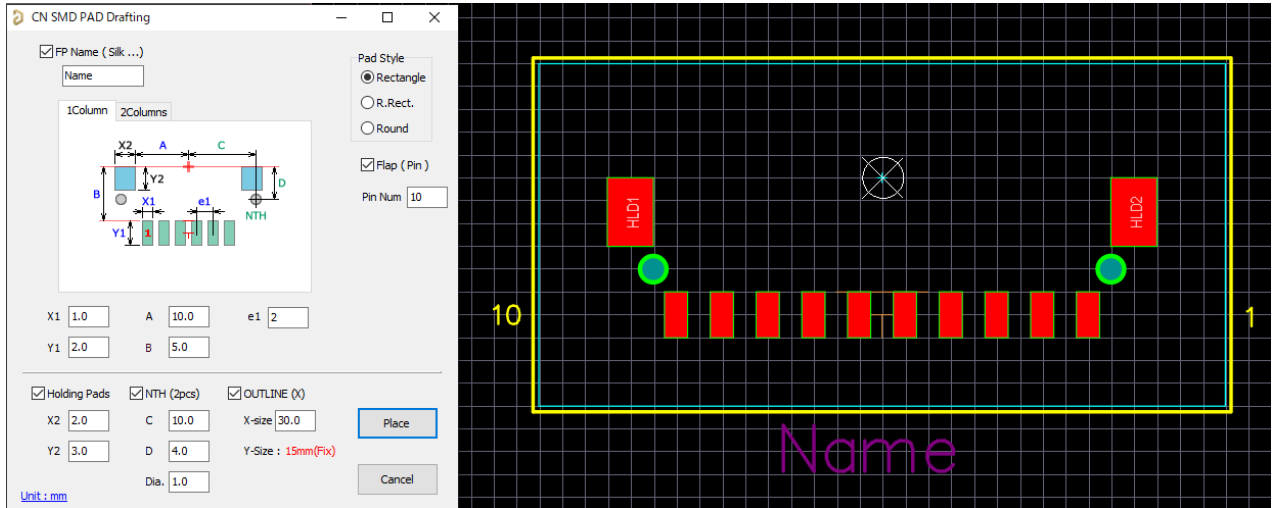

D_DW

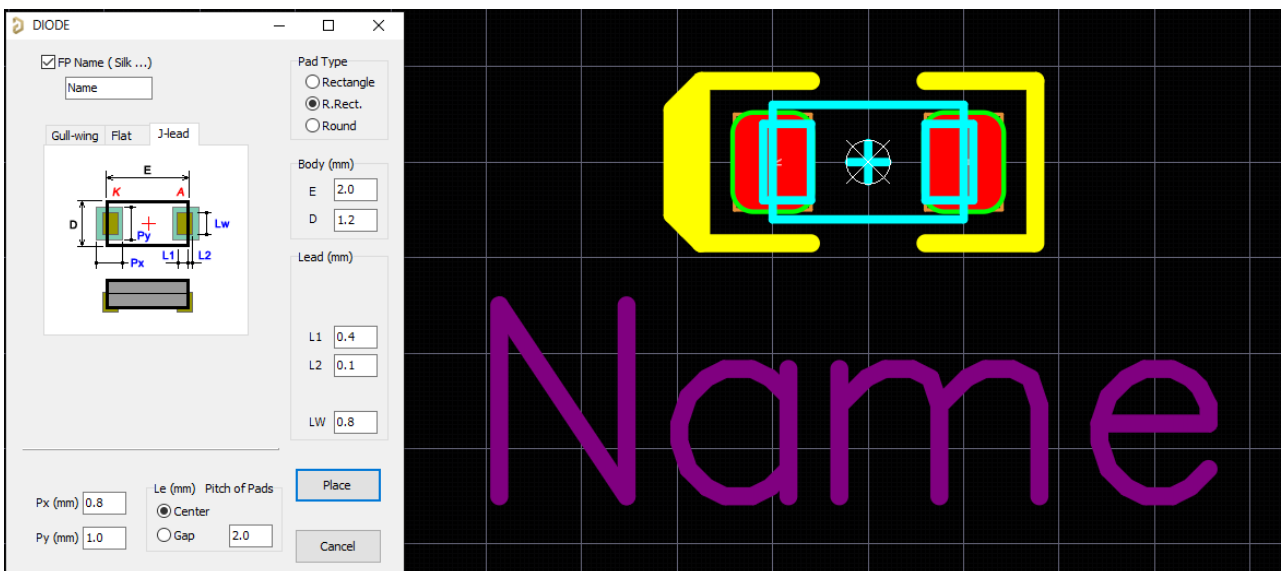
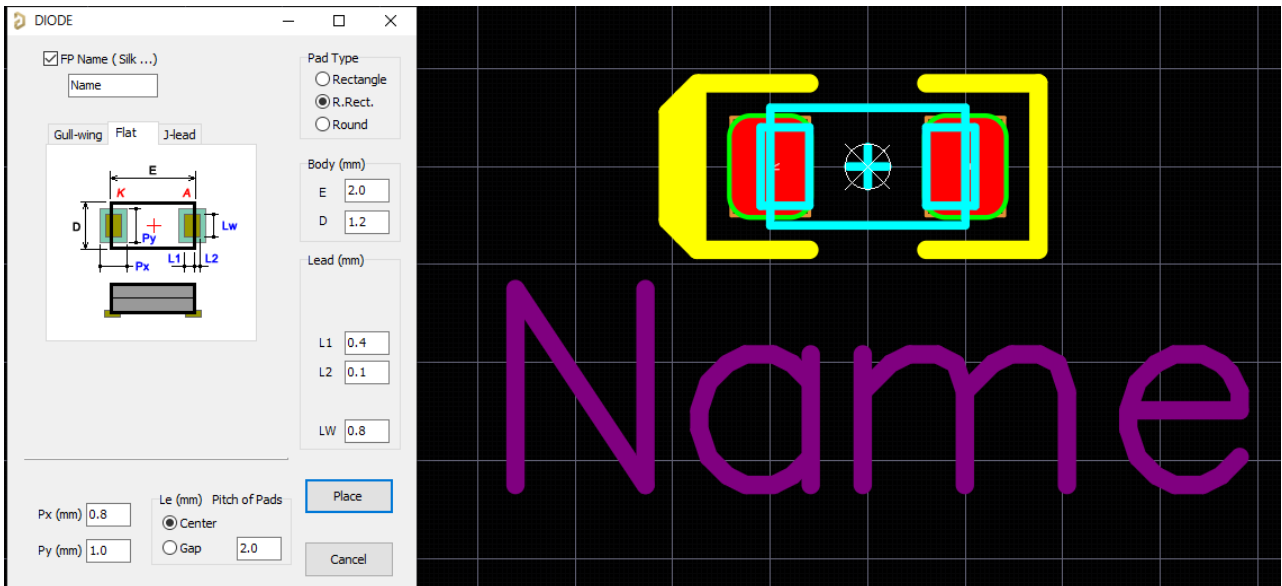
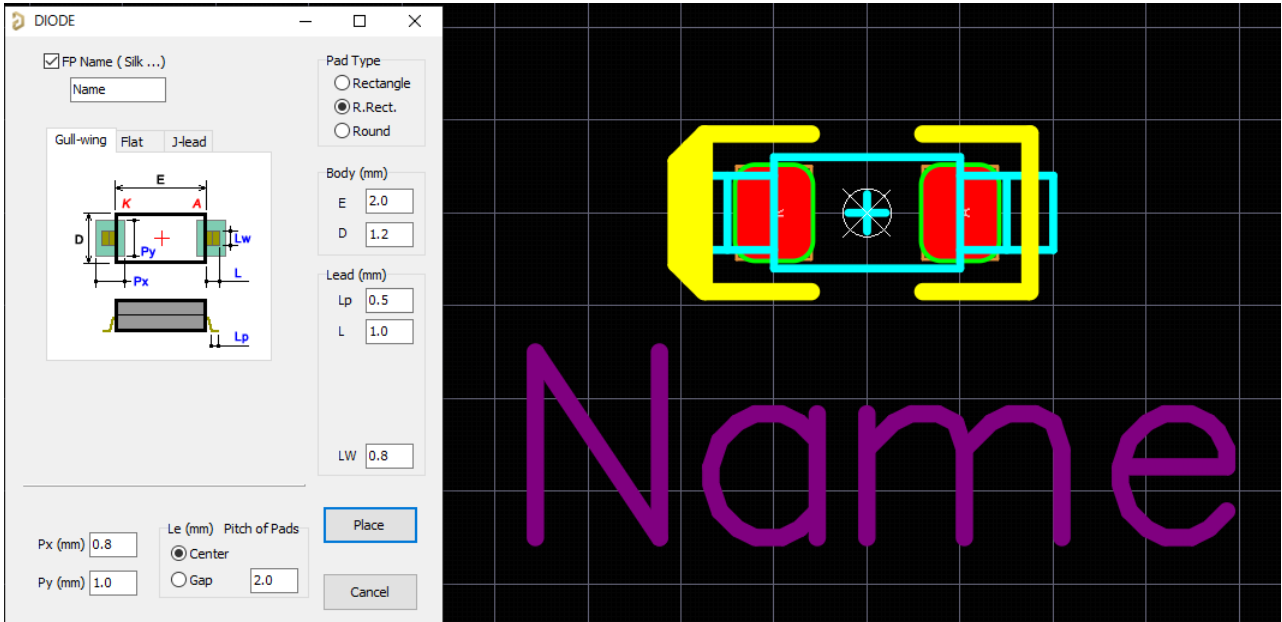

DFN_DW

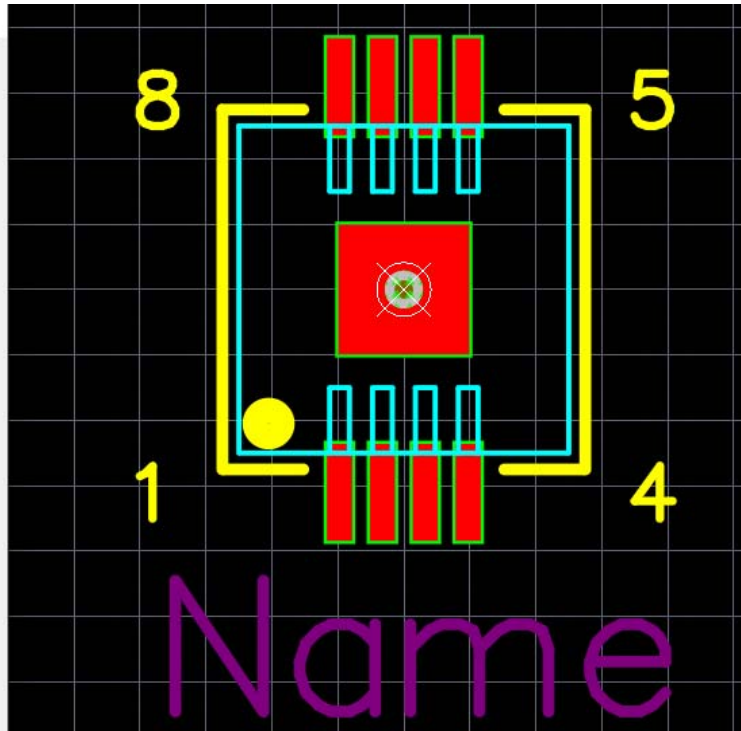
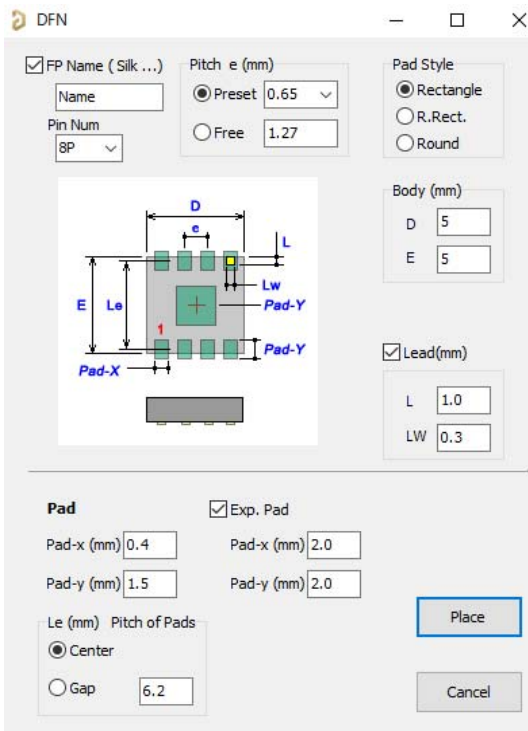

L_DW SUMIDA

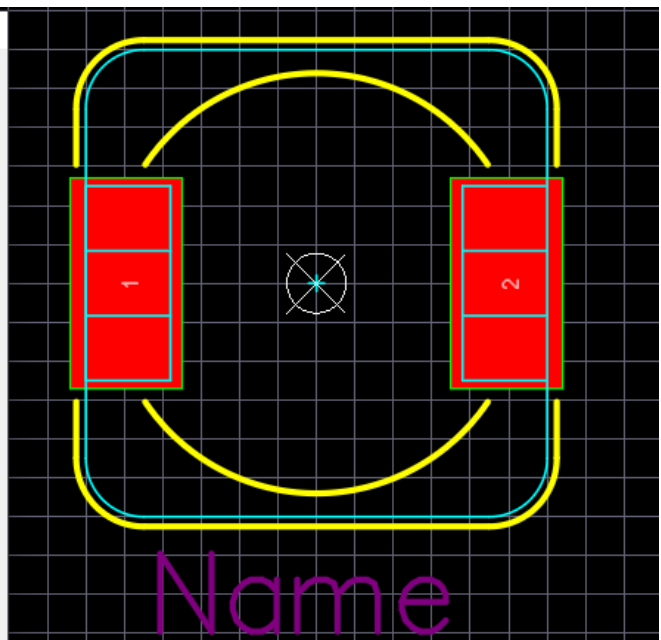
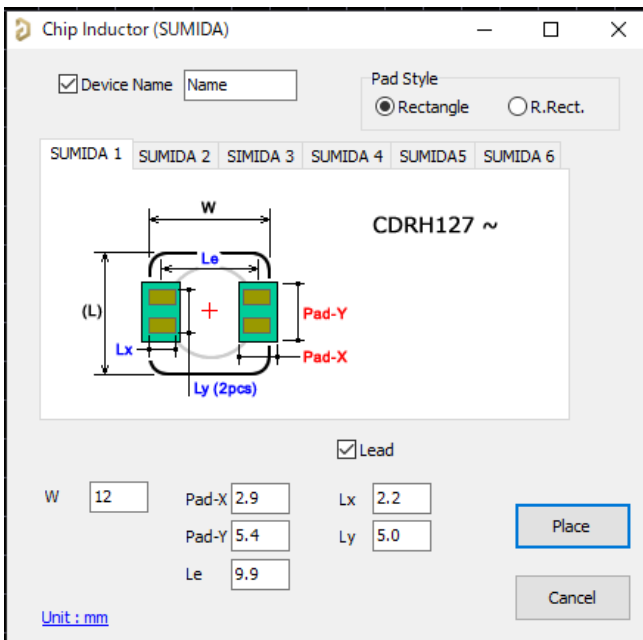

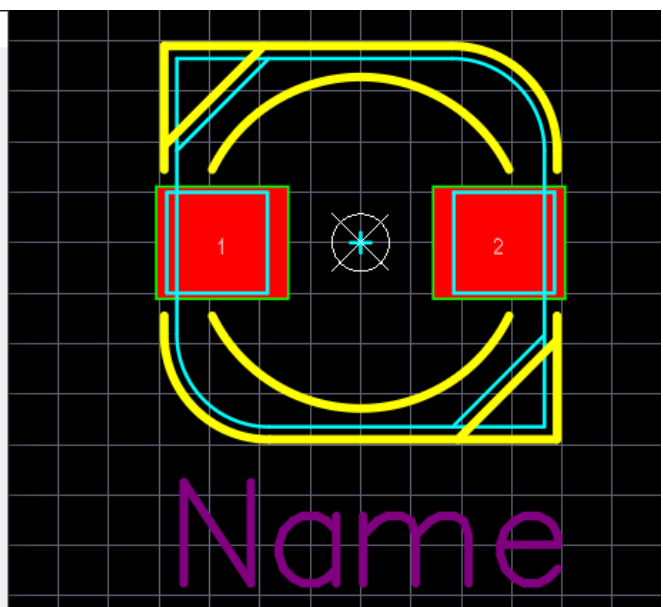
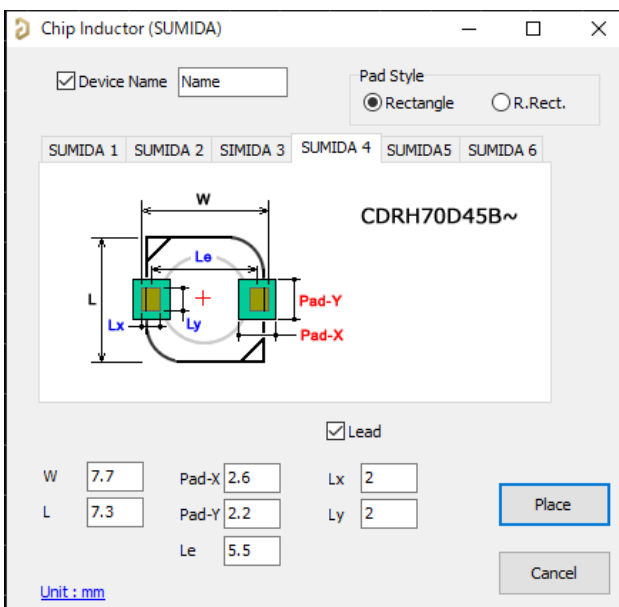
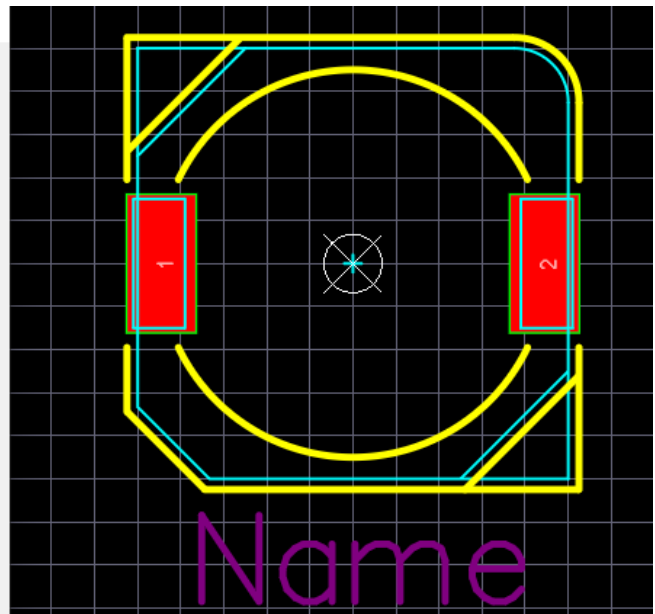
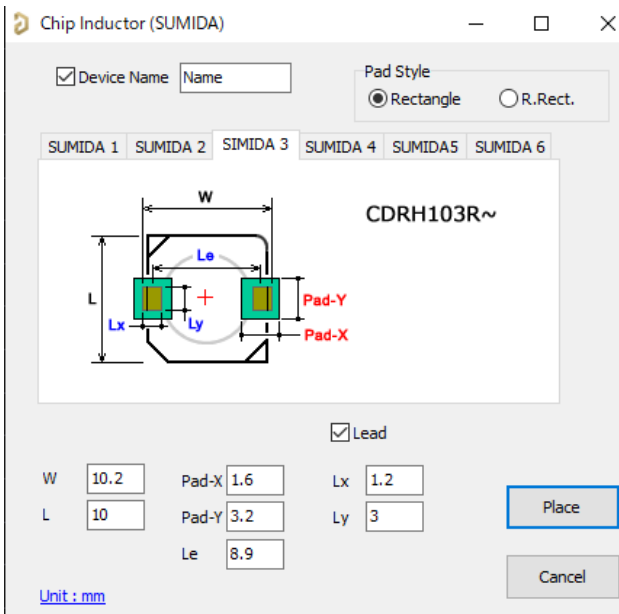
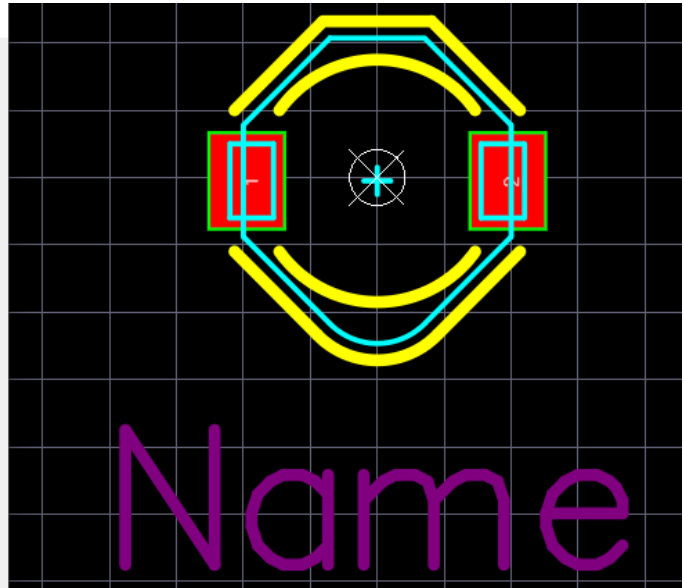
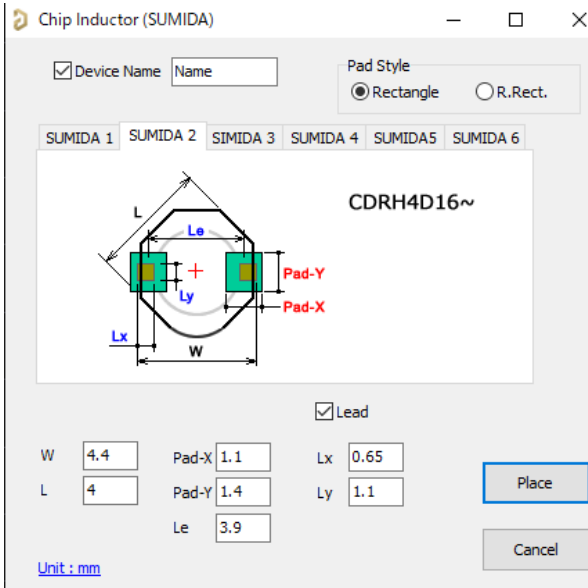

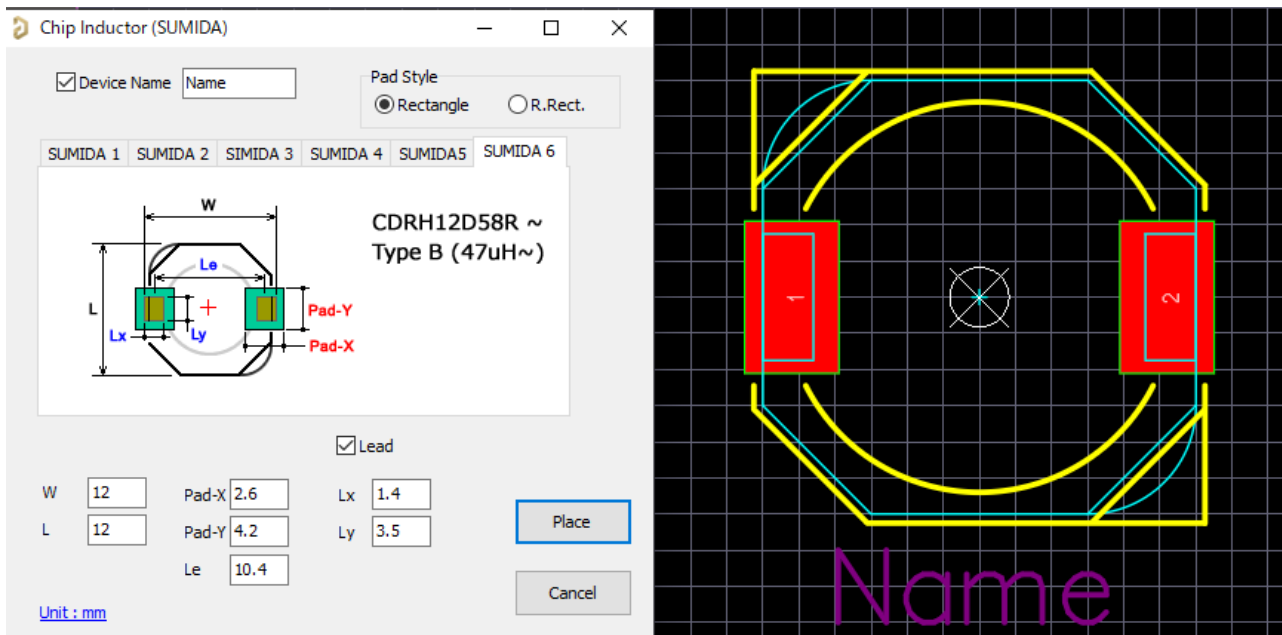
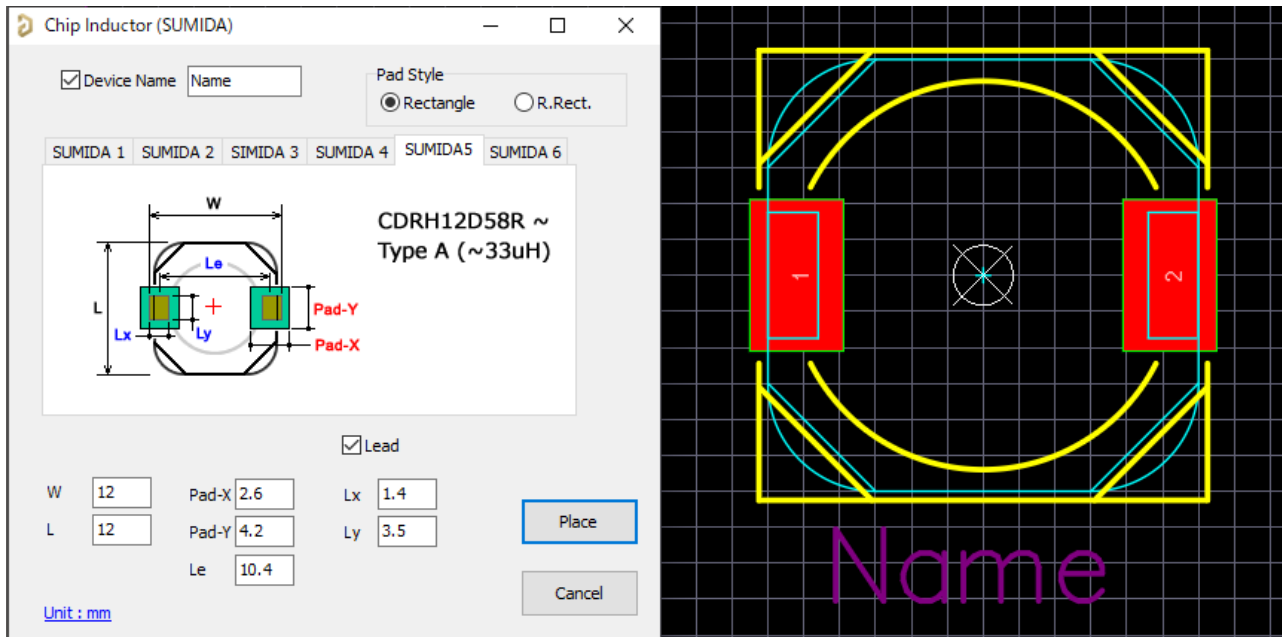

L_DW TDK

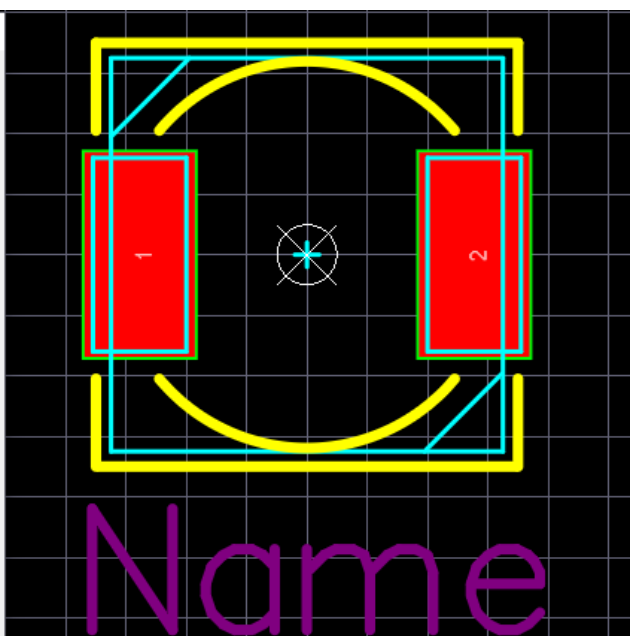
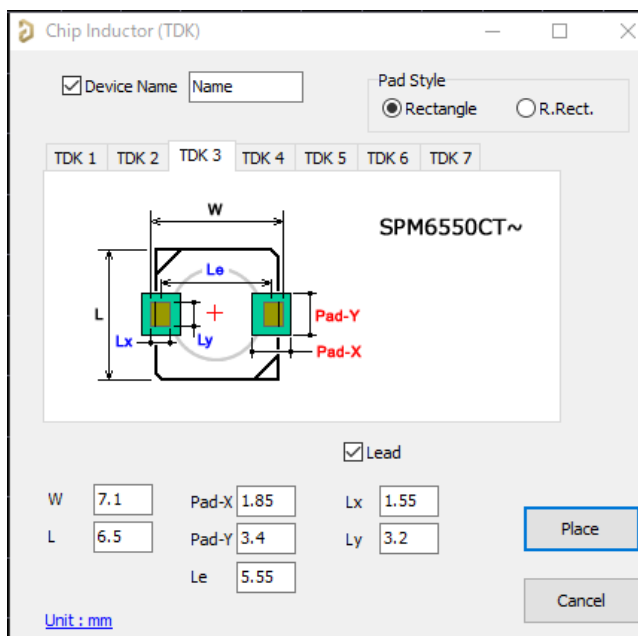
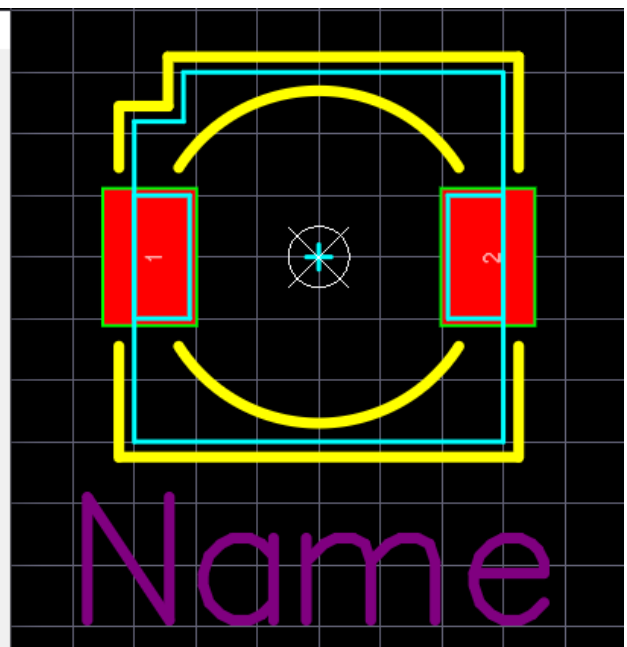
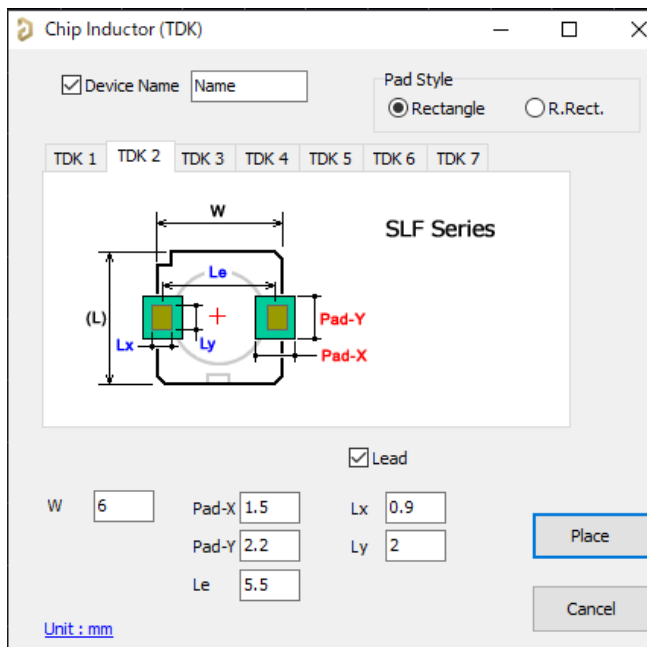
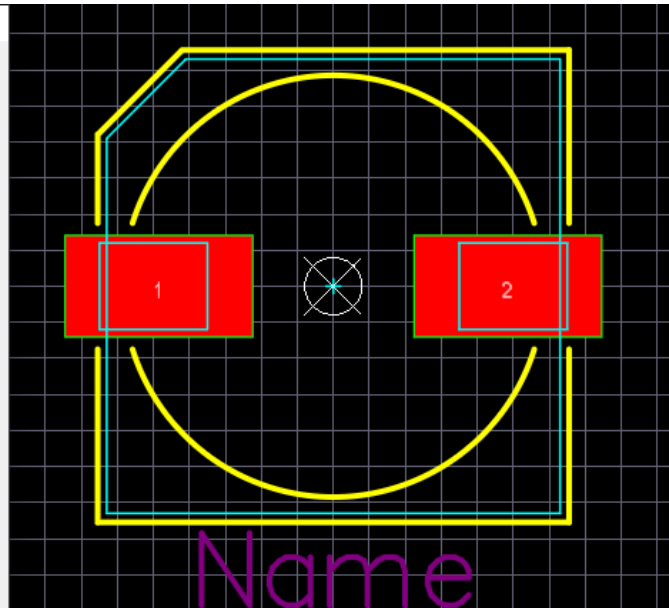
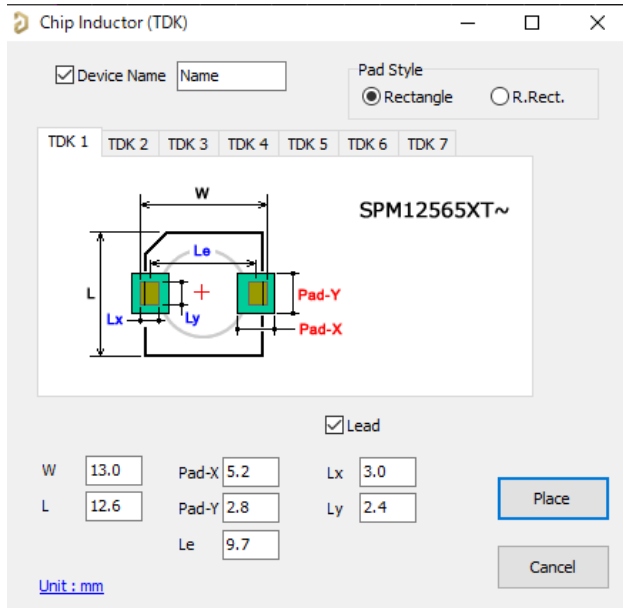

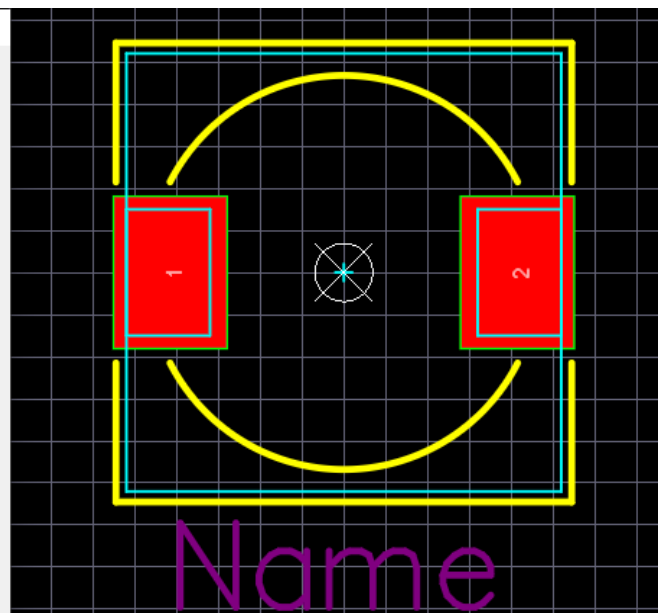
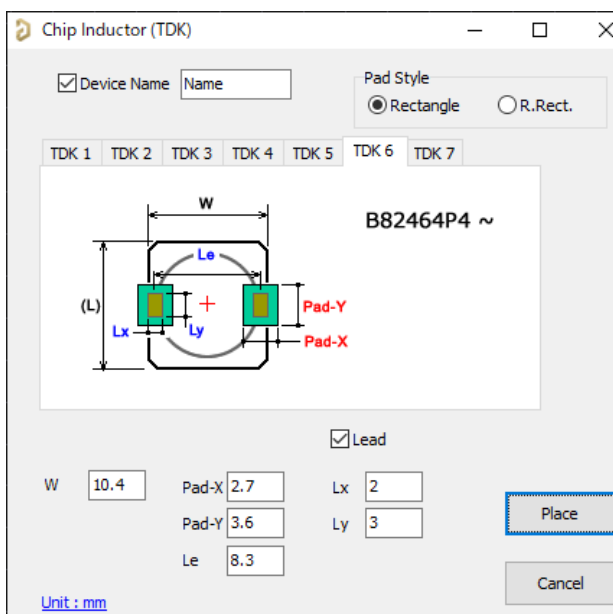
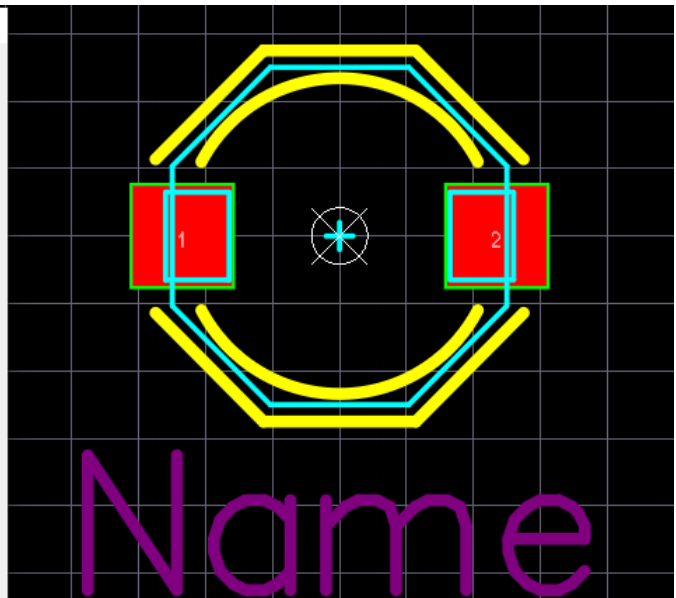
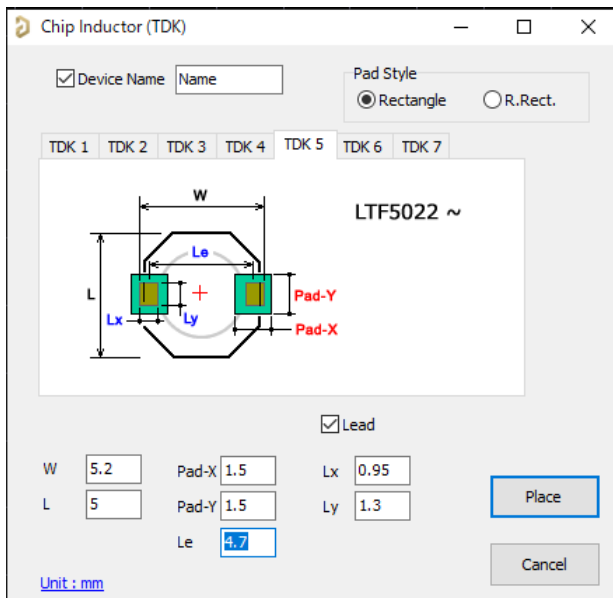
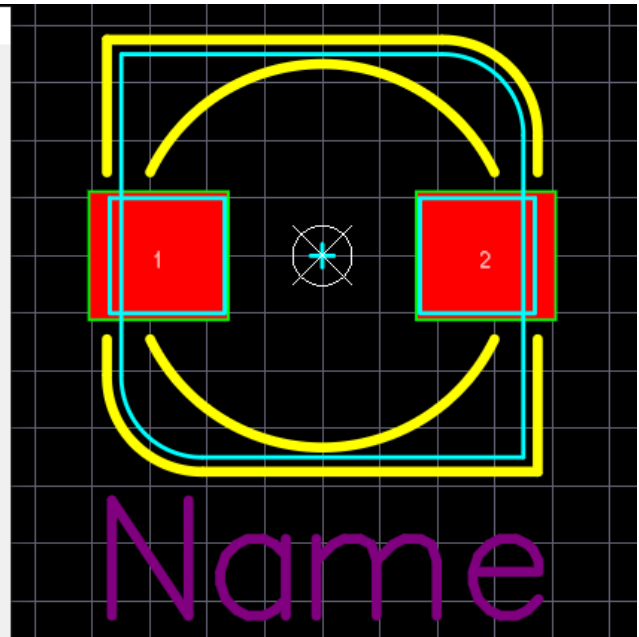
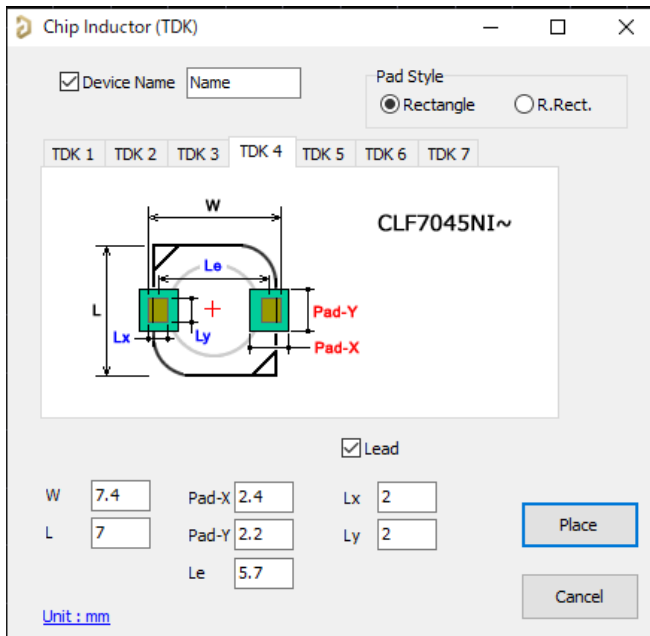

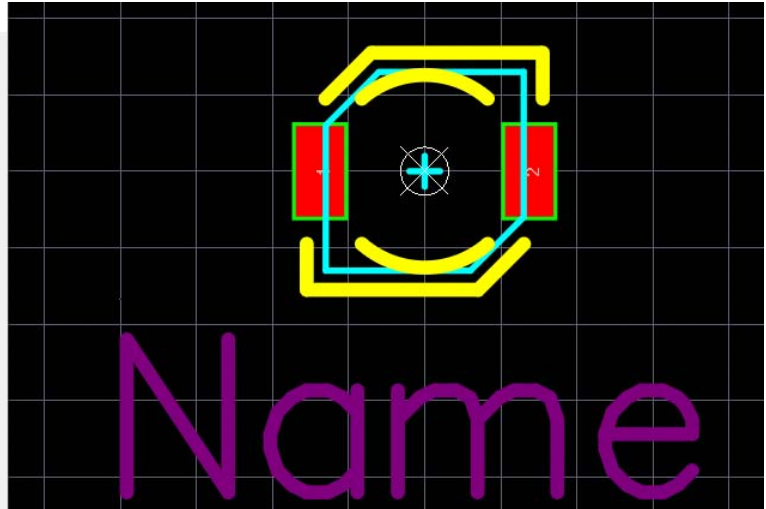
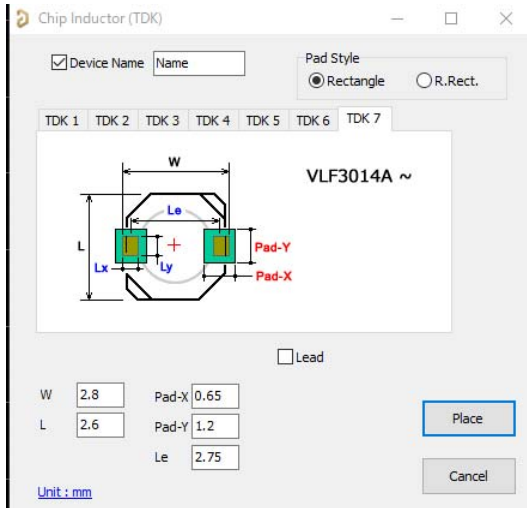

L_DW UNI

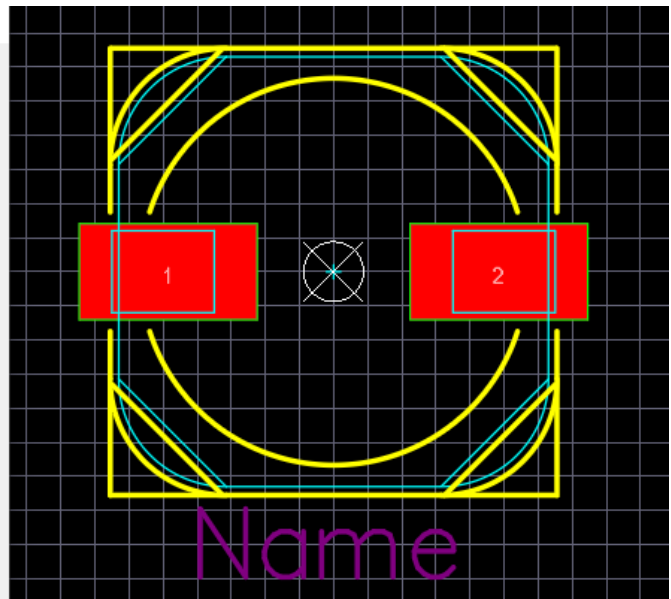
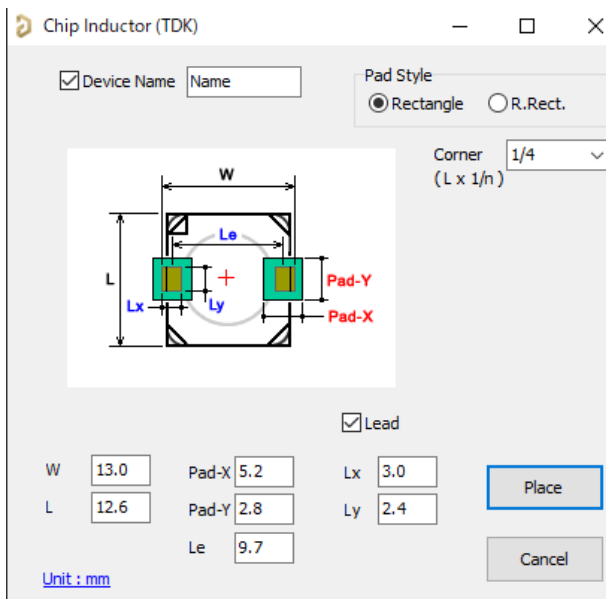

LCR_DW

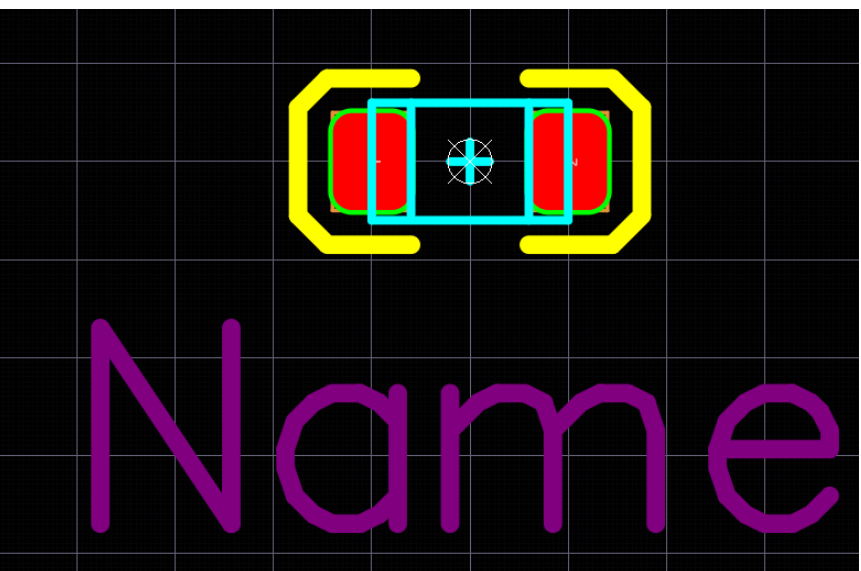
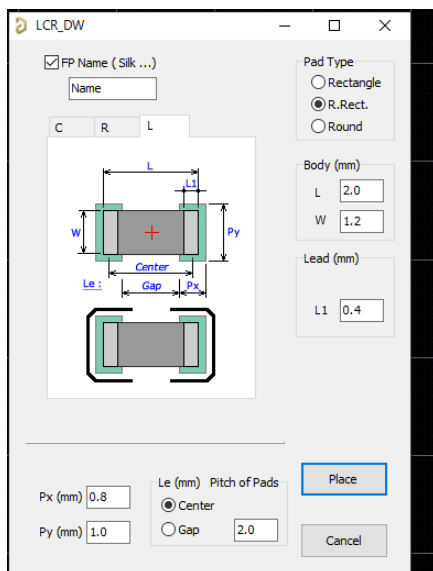
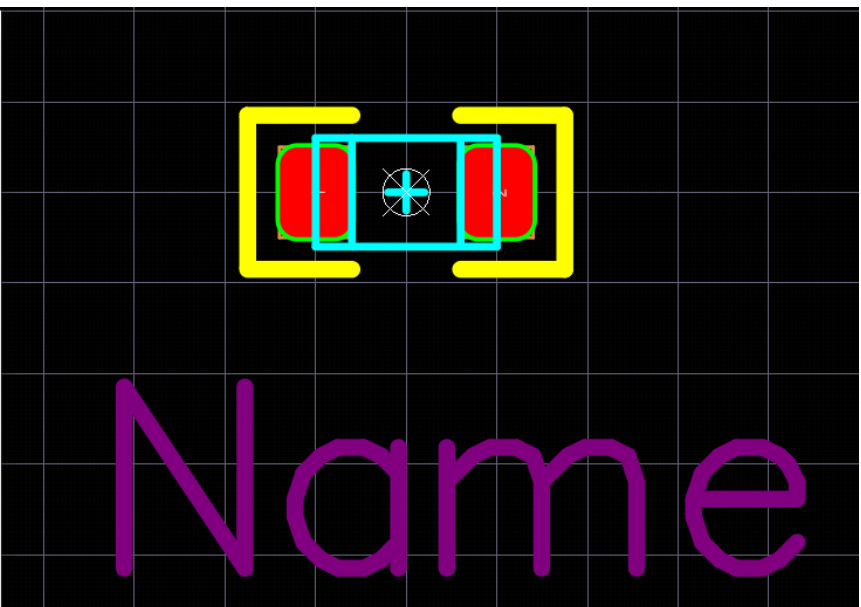
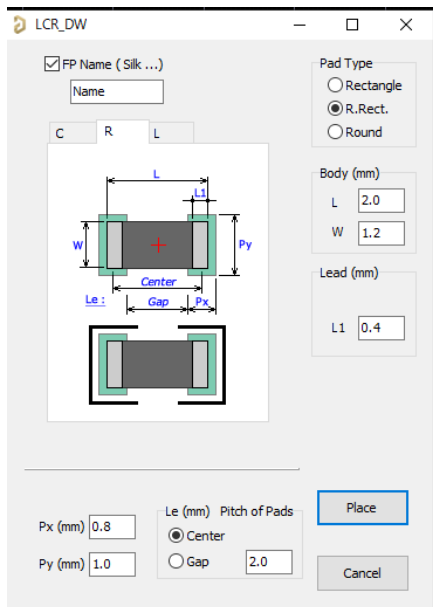
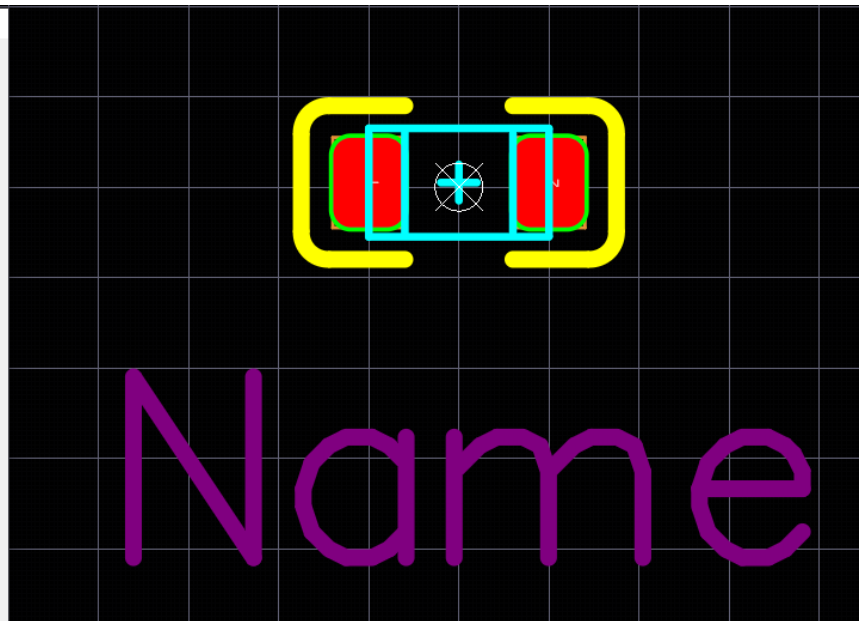
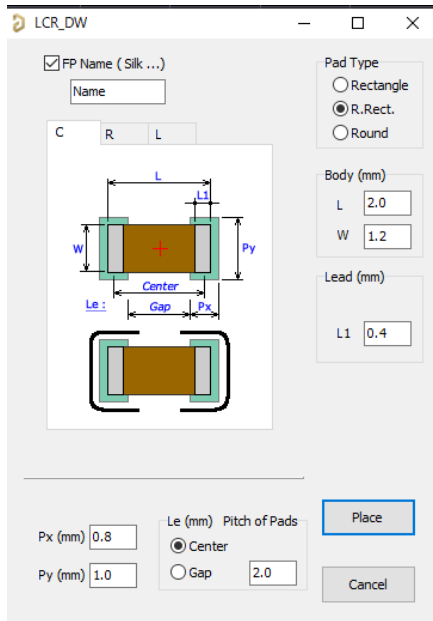

QFN_DW

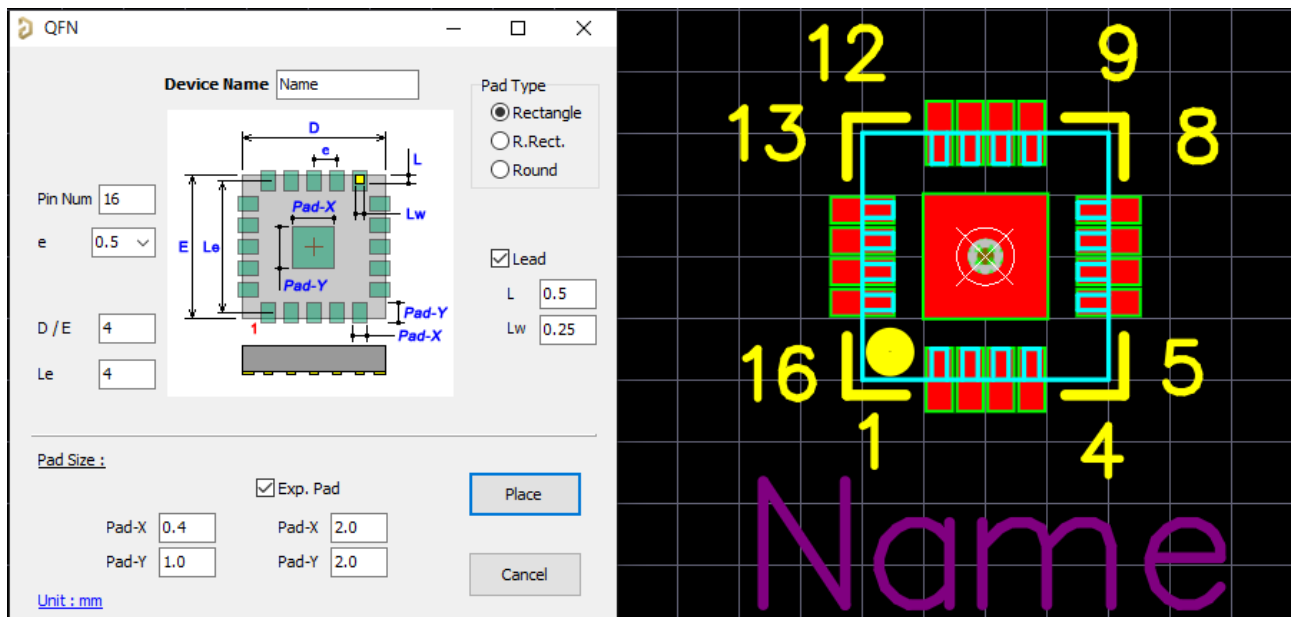

QFP_DW

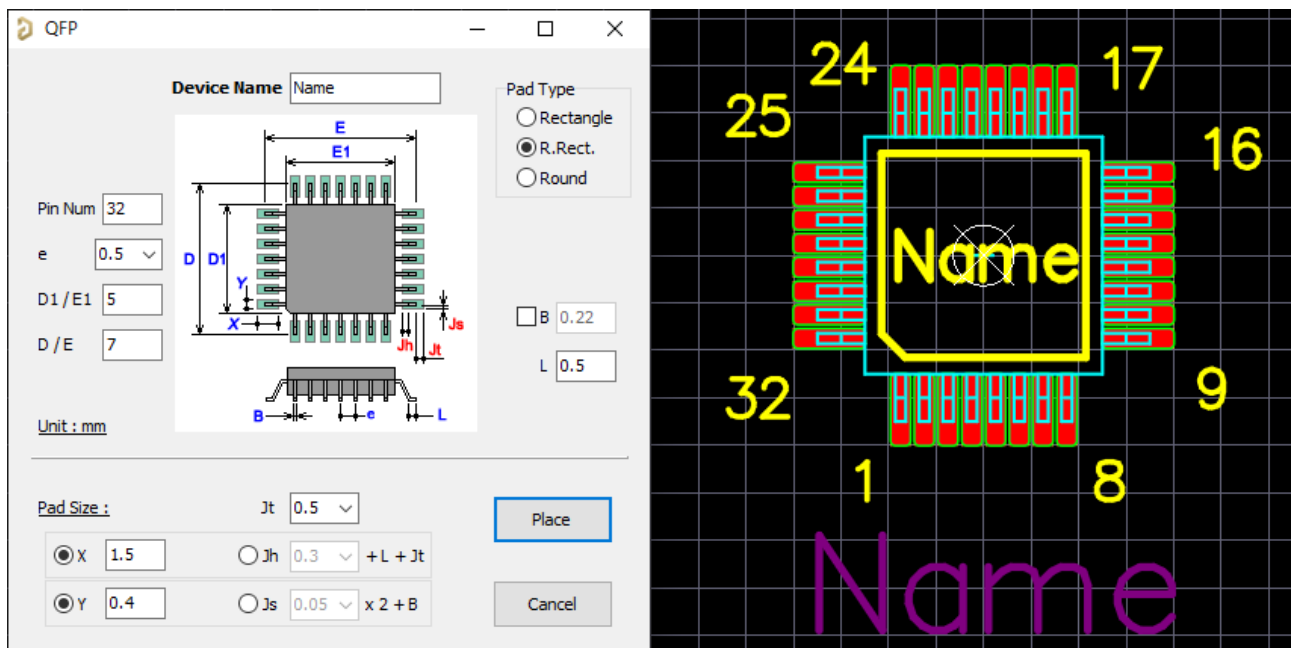

SOP_DW

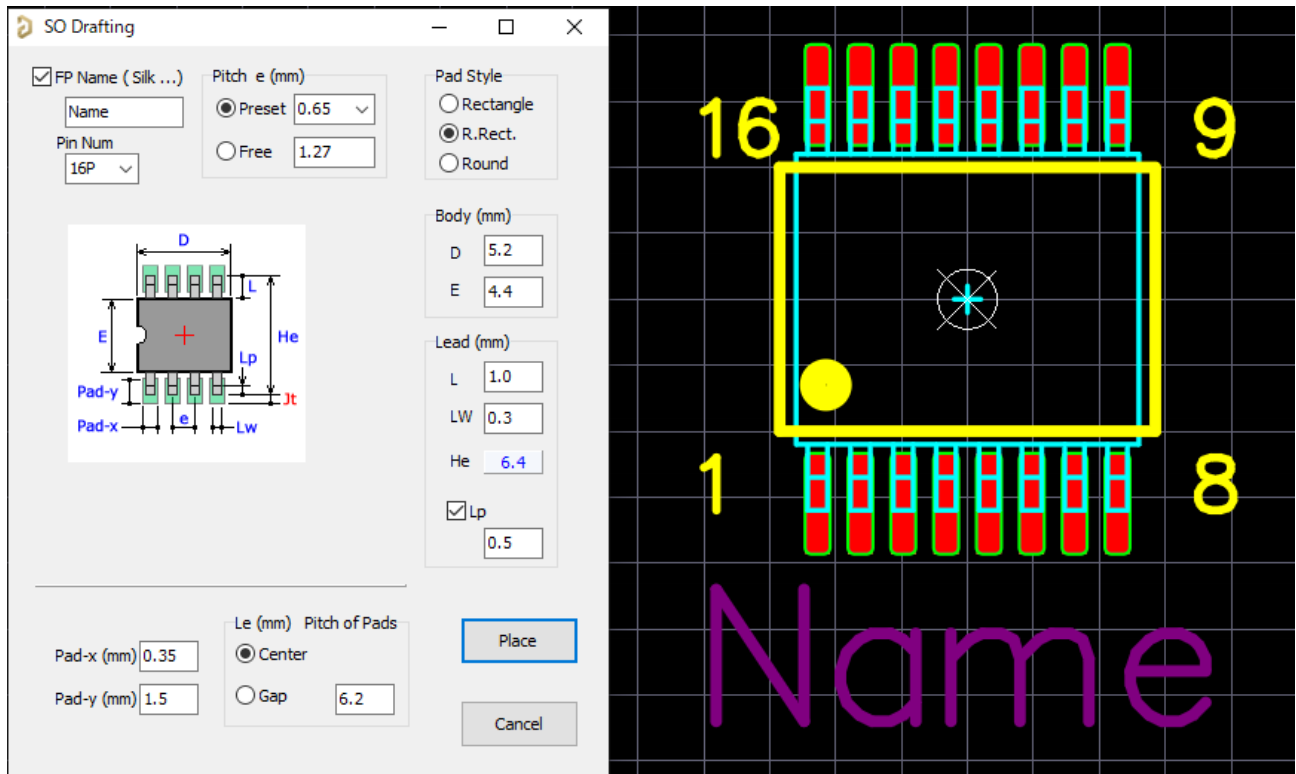

SOT3_6_DW

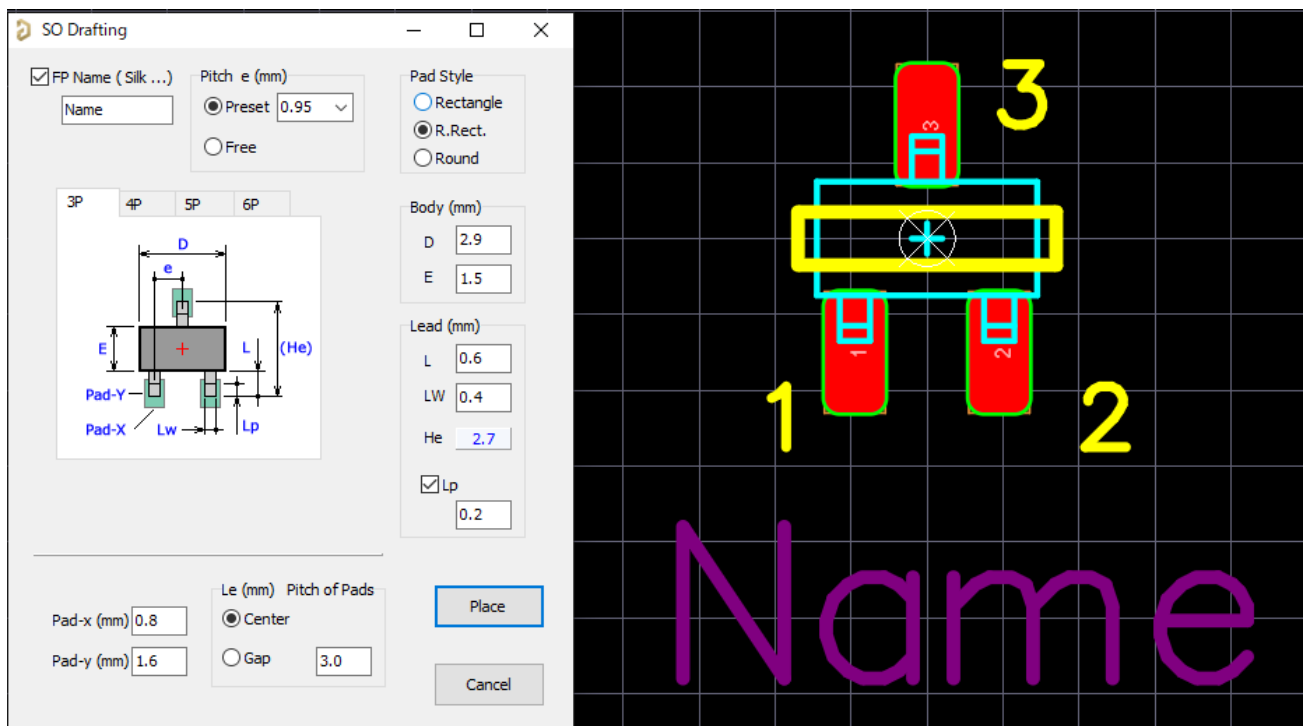

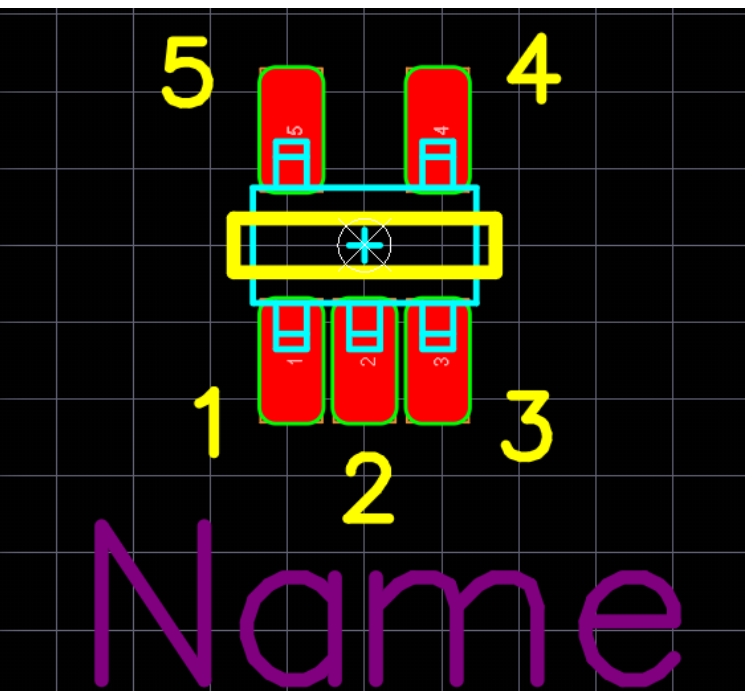
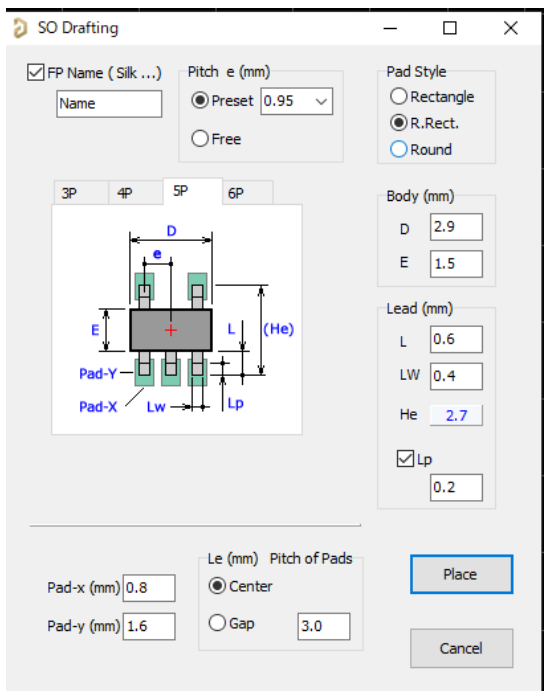
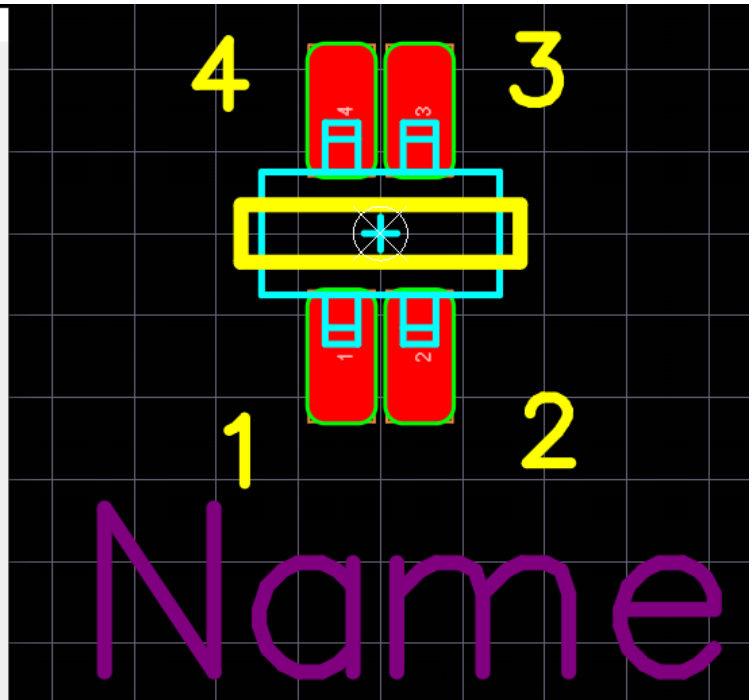
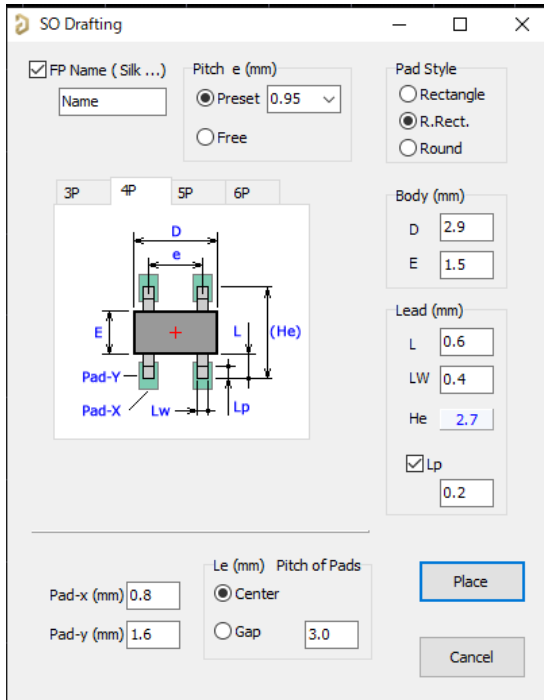

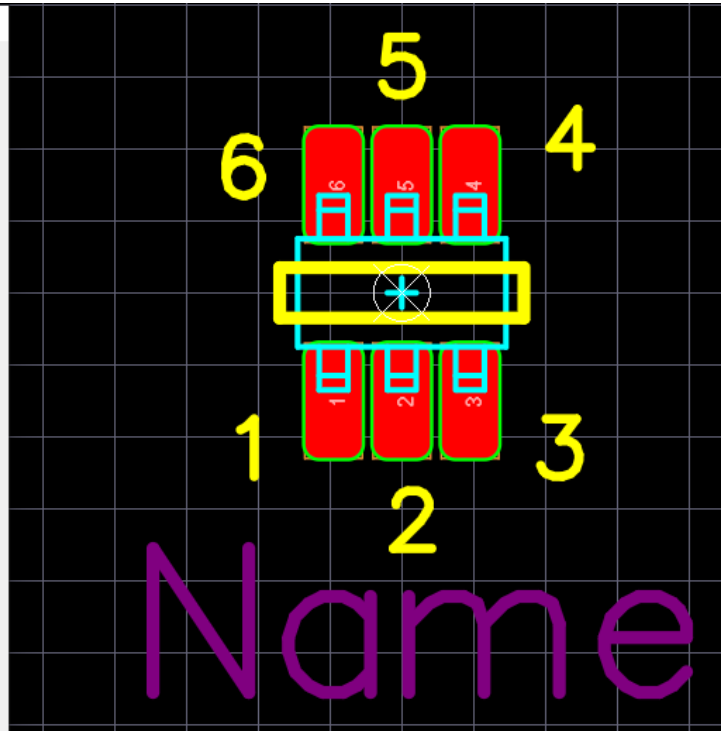
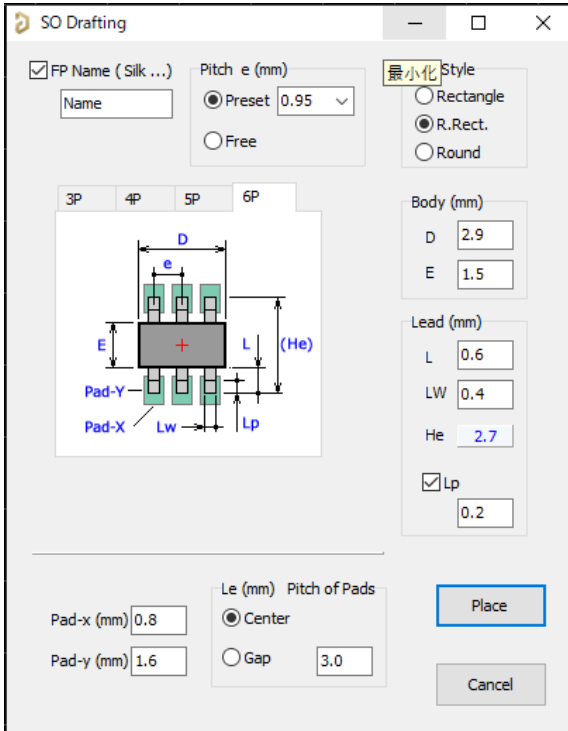

TN_SMD_DW

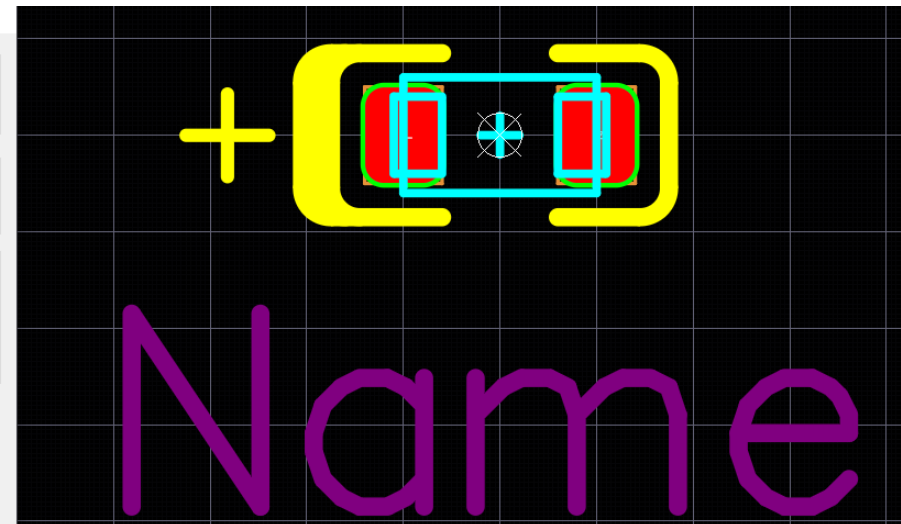
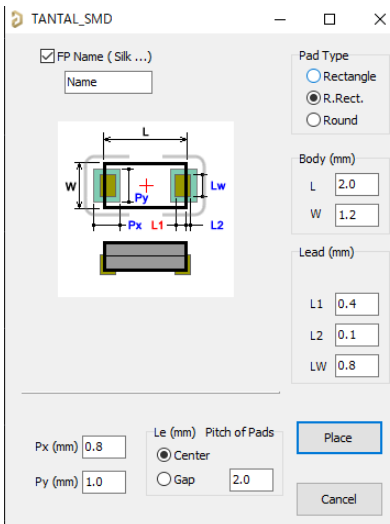

4_6P_DW

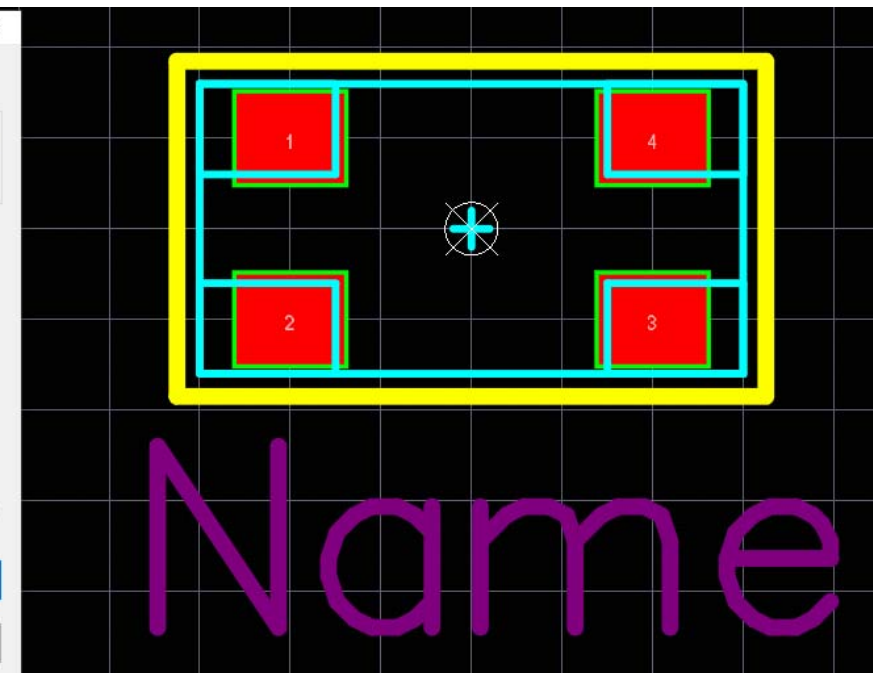
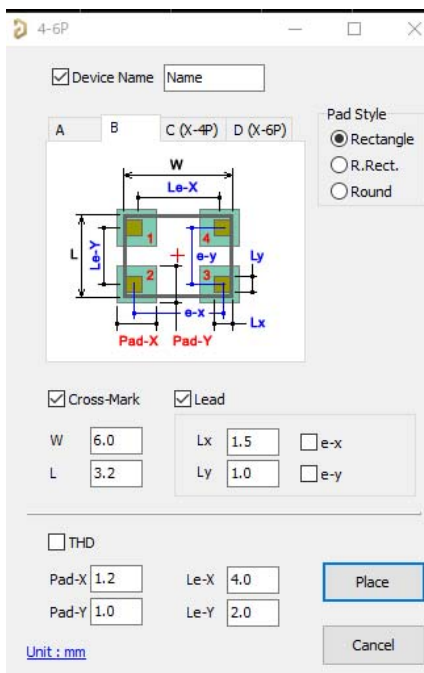
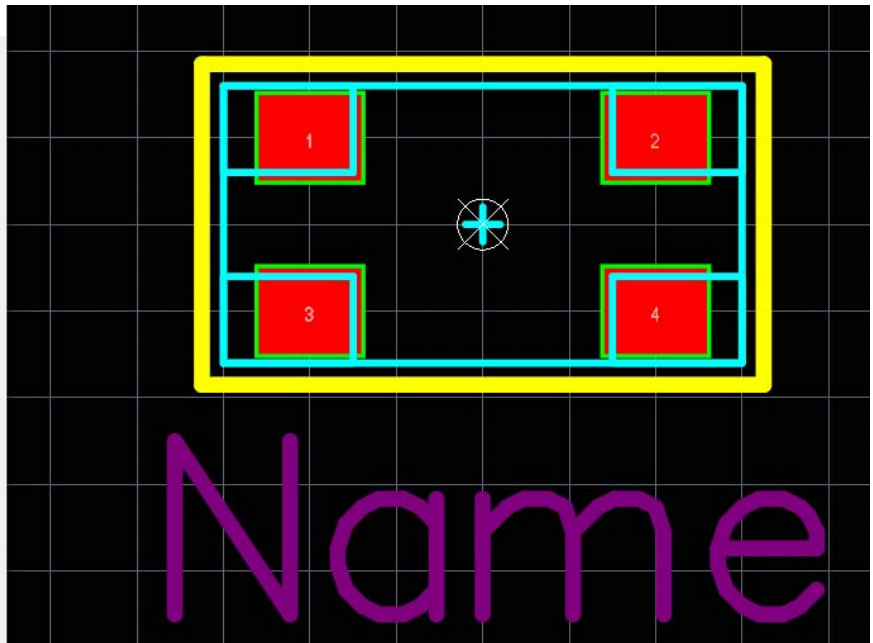
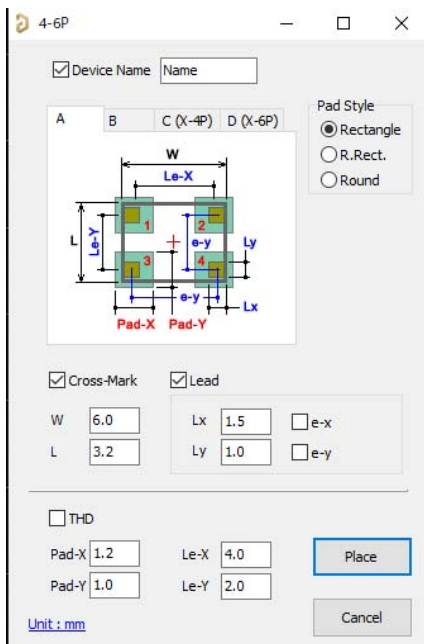

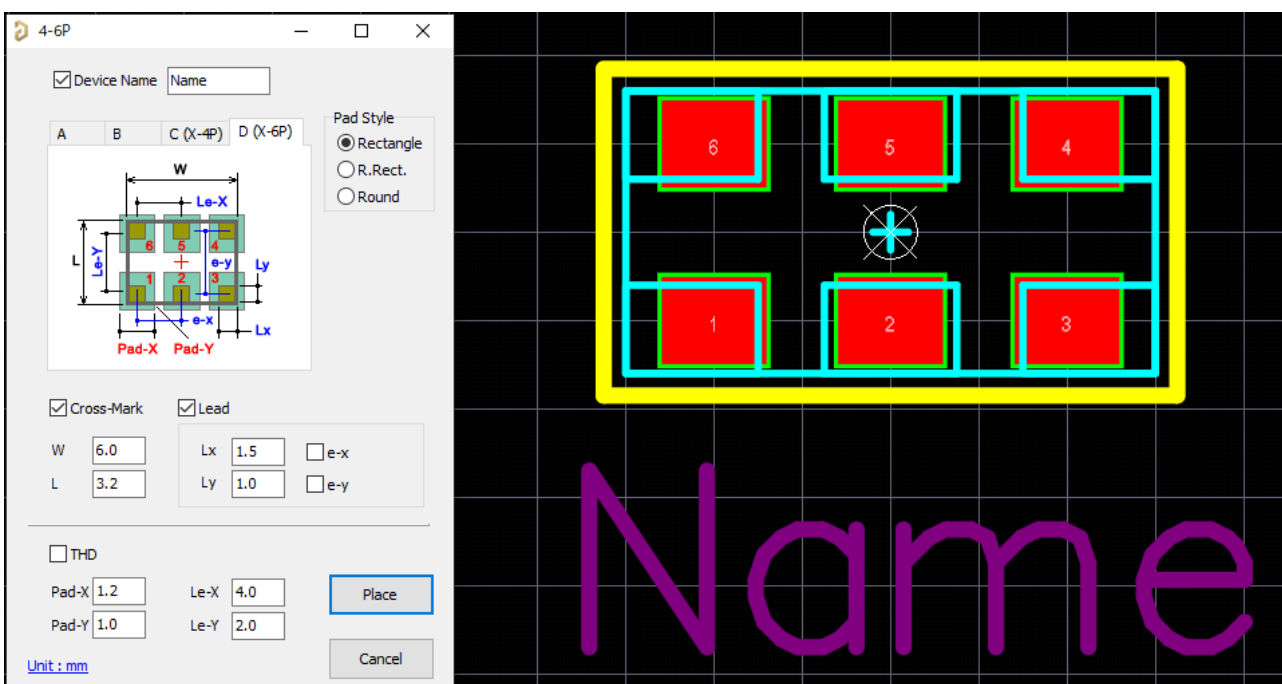
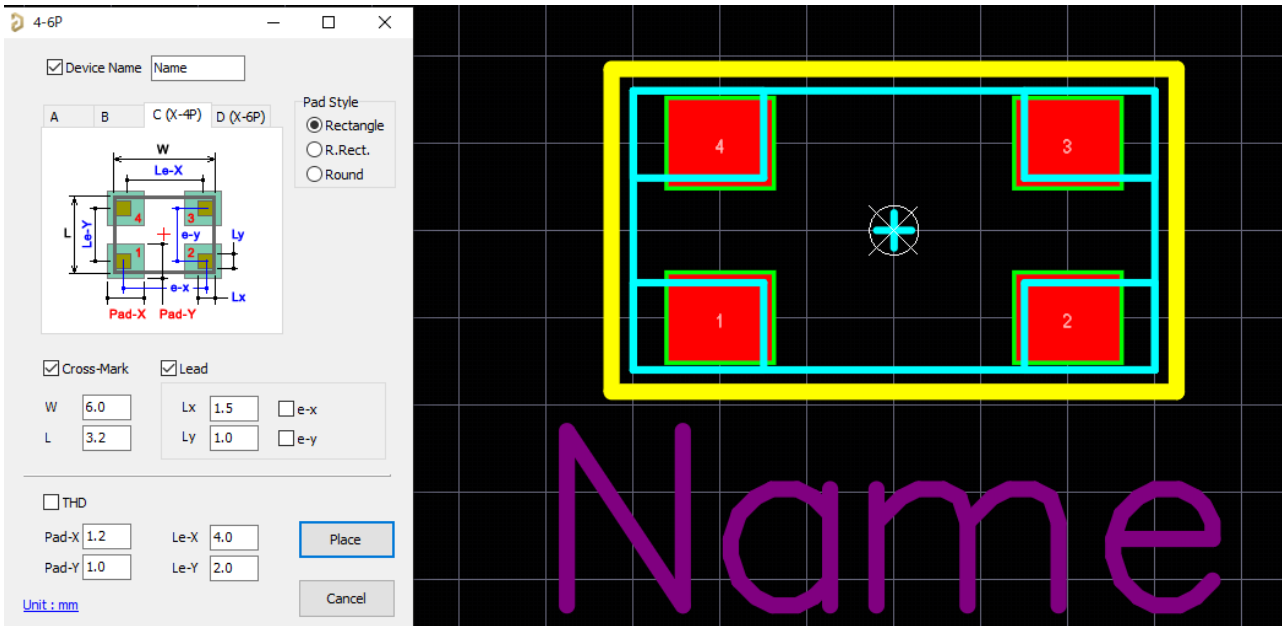

FootPrint_Collection

部品ライブラリー名一括レポート出力

Glue_Size_Calc

実装用接着剤サイズ算出

SLOT_1.08

異形リードの楕円サイズ算出